

STANLEY

InnerSpace

# Small Storage & Procedure Carts



Fall 2010

**STANLEY**

# InnerSpace®

For more than 25 years, Stanley InnerSpace has specialized in healthcare storage products that deliver optimal solutions throughout every room of the hospital.

- Today's most effective medical storage and inventory management systems
- Comprehensive selection of carts, cabinets, and inventory management options
- Endless configuration options
- Free layout assistance and free custom design drawings

Work more efficiently and save money with a storage system designed to your exact requirements! For a full line catalog or to schedule a free onsite storage analysis, call **800.467.7224** or visit **StanleyInnerSpace.com** today.

- 3 ILS: Intelligent Locking System
- 5 Small Cart Lineup
- 7 Preconfigured Carts
- 9 Mini Carts
- 10 Bedside Charting Accessories
- 11 Build-a-Cart
- 16 Cell System
- 17 Tray Trolleys
- 19 Personal Workstations
- 20 Product Specs
- 25 Specialty Small Carts

#### LOCKING OPTIONS



ILS: Intelligent Locking System



Prox Card Access



Coded Keypad Access



Key Access

# The Stanley® InnerSpace® Small Cart Advantage

- All Harmony® carts are built around a central design platform, utilizing the same base and top while sharing many common components
- Number of unique parts are reduced, enhancing overall design quality
- Extremely versatile—Harmony carts with drawers or Cell panels utilize the same removable plastic trays and baskets
- Integral brackets and slotted corner posts increase versatility by providing an easy means of attaching top- and side-mounted accessories



## FUNCTIONALITY

Full complement of accessories accommodates a variety of medical equipment and point-of-use storage needs.

## VERSATILITY

Use the Build-a-Cart option to create the custom cart that best suits your needs! Three drawer sizes house optional trays and dividers.

## SECURITY

Standard central key lock secures all drawers. Electronic keyless entry options take security to the next level (keypad, prox card, or ILS: Intelligent Locking System).

## SECURITY MANAGEMENT

Use ILS to program carts from any PCI. Add and delete users, adjust cart settings, and track user activity.

## CONVENIENCE

Pullout shelf expands work area and provides extra writing surface!

## DURABILITY

Precision-welded steel frames, ABS padded steel bumpers, thick aluminum posts, powder-coated panels.

## STYLE

Brushed aluminum corner posts, seamless work surfaces, integrated accessory mounting.

## MANEUVERABILITY

Heavy-duty 5-inch full-swivel ball-bearing plate casters (2 locking, 1 tracking) plus a low center of gravity.



# Stanley® InnerSpace® ILS: Intelligent Locking System

The right carts are an integral part of your clinical supply chain. Once you've selected your ideal small cart setup, these carts can have a tremendous effect on your bottom line, and their security is of the utmost importance. Physical keys are a thing of the past. The answer? ILS, today's most intelligent wireless locking system.

Engineered to save you money, time, and headaches, ILS small carts are part of a wireless web-based tracking system that allows cart access programming from any computer. Manage all user information from any PC!

## How does the ILS system work?

- Web-based interface allows you to edit users at any time from any computer
- Assign users to carts with one drag-and-drop
- Users can be deactivated from any or all carts
- Track user activity through a real-time audit trail

## What are the main ILS small cart features?

- Wireless network—no need to program individual carts
- Users can access carts via prox card or keypad code
- Will not interfere with existing hospital WiFi network
- Supports 8500 prox card credentials, plus another 1000 pin codes

## What benefits can I expect from the ILS system?

- Unparalleled level of cart security
- Reduced management time and effort
- Value-added reporting capabilities
- Minimal administrator training required
- Online battery alerts

## Why choose InnerSpace carts?

- User-friendly security options
- The ultimate in style, versatility, and maneuverability
- Wide range of drawer configurations, colors, and accessories
- Carts are guaranteed to suit your facility's unique needs





# Always stay connected...

Because the ILS system is so easy to use, managing any number of carts and cart users is extremely simple. By connecting ILS small carts through a wireless system, InnerSpace gives you the power to control all user information from a single PC:



# ...and turn hours into minutes with ILS!

ILS small carts allow you to command and control cart access, ensuring supply security. Take a closer look at the dramatic time savings ILS small carts offer over the competition:

COMPETITOR	ILS
<b>Adding 50 users to 100 carts:</b>	

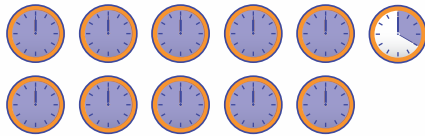

Estimated Time: 10 hours and 20 minutes



Total Time: 15 minutes

COMPETITOR	ILS
<b>New employee needs prox access to 100 carts:</b>	

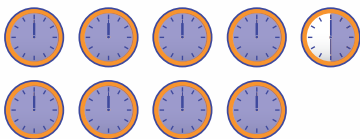

Estimated Time: 8 and a half hours



Total Time: 15 minutes

# Small Cart Lineup

Designed to meet every one of your mobile medical requirements, Stanley® InnerSpace® small carts are available in your choice of four frame sizes or models (standard with preconfigured drawers). Standard features include 5-inch plate casters, central key lock, and pullout writing surface.

If custom carts are required, InnerSpace's Build-a-Cart option (Page 11) provides you with the power to configure your carts to your exact needs. A full complement of cart accessories is also available (Page 13).

## Harmony: Preconfigured



6321W4



6324W5

## Tray Trolley

- Interior accessories include locking drawers, trays and dividers, shelves, and wire baskets
- Standard easy-close locking drawer door
- Can be configured in numerous ways for a variety of procedural and storage needs
- Quick, easy access to all supplies
- 5-inch full-swivel casters, 2 with locks



Shown with optional accessories.



6327W6



6330W6

## Personal Workstation

Ideal for the lightweight transport of supplies or maneuvering in tight spaces, the Stanley® InnerSpace® Personal Workstation is a mere 20-5/8 inches wide and 20-5/8 inches deep. Work surface is height-adjustable from 35-1/2 inches to 46 inches.



# Preconfigured Carts

Width: 27-1/8" (68.9cm)  
 Depth: 21-1/8" (53.7cm)  
 All Four Sizes

## Solid White



6321W4, 6321W42C\*  
 36-1/2" (92.7cm)  
 33-1/2" (85.1cm)



6324W5  
 40" (101.6cm)



6327W6  
 43-1/2" (110.5cm)



6330W6  
 47" (119.4cm)

Overall Height (Includes Casters)

## Solid Color



Crash Cart  
 6324R5 (cart only)  
 6324RVP (with CVP)\*\*



Anesthesia Cart  
 6324B5 (cart only)  
 6324BVP (with AVP)\*\*



Isolation Cart  
 6324Y4



## Two-Tone



Crash Cart  
6330R6 (cart only)



Anesthesia Cart  
6330B6 (cart only)



Isolation Cart  
6330Y6 (cart only)



Pediatric Emergency  
6327PED (cart only)



Line Cart (Central or PICC)  
6324LINE  
Includes VIV, VUR2,  
VTB4, VTD-2, VSC5



Suture Cart  
6324SUT  
Includes VUR2, VSS (2)

# Mini Carts

A slimmer version of the 6321W4 small cart, the Mini Cart is designed for small spaces such as under countertops, patient bedsides, exam rooms, and rooms with limited space. We've trimmed 4-1/2 inches off the height, almost 2 inches off the depth, and over 3 inches off the width.



- 3-inch full-swivel plate casters (2 with brakes, 1 with tracking)
- Optional flip-up writing surface
- 21" W (53.3cm) x 14-5/8" D (37.1 cm) drawer interiors



**6321MINI**  
Preconfigured, 4 Drawers  
Width: 24" (60.9cm)  
Depth: 19.6" (49.9cm)  
Height: 32" (81.3cm)



**6321MINIWN**  
Build-a-Cart, No Drawers  
Width: 24" (60.9cm)  
Depth: 19.6" (49.9cm)  
Height: 32" (81.3cm)

# Bedside Charting Accessories

Turn your small cart into a computer-compatible bedside charting and storage cart! Position cart as needed so you can communicate and chart while looking at the patient.



- Full-sized drawers can be used for patient personnel items, patient-specific supplies, or other items
- Order separate options as needed
- Lots of workspace, lots of storage space



**Laptop Version**  
Shown with height-adjustable laptop tray.



**Flat-Panel Version**  
Shown with height-adjustable keyboard tray, flat-panel arm, and flip-up writing surface.



**FPMA**  
Flat-Panel Monitor Arm



**VKB-1**  
Articulating Keyboard



**VPT**  
2.5" Pass-Through Hole



**HDC**  
Drawer Cover

# Build-a-Cart

The Build-a-Cart option allows you to choose the cart sizes, drawer sizes, color configurations, and trays and dividers that best suit your needs.



Lavender



Teal



Light Blue



Green

## STEP 1: Choose cart size and color.

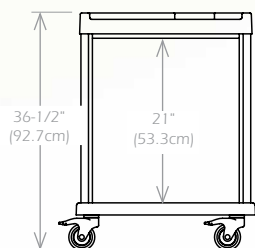

6321WN – White  
6321RN – Red  
6321BN – Blue  
6321YN – Yellow

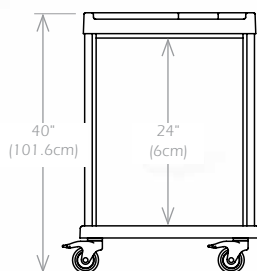

6324WN – White  
6324RN – Red  
6324BN – Blue  
6324YN – Yellow

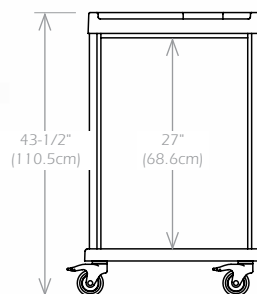

6327WN – White  
6327RN – Red  
6327BN – Blue  
6327YN – Yellow

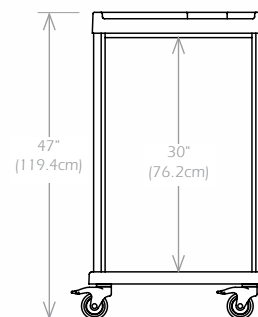

6330WN – White  
6330RN – Red  
6330BN – Blue  
6330YN – Yellow

## STEP 2: Choose drawer size and color.



White

3" – 63-3DW  
6" – 63-6DW  
9" – 63-9DW



Red

3" – 63-3DR  
6" – 63-6DR  
9" – 63-9DR



Blue

3" – 63-3DB  
6" – 63-6DB  
9" – 63-9DB



Yellow

3" – 63-3DY  
6" – 63-6DY  
9" – 63-9DY



Orange

3" – 63-3DO  
6" – 63-6DO  
9" – 63-9DO



Green

3" – 63-3DG  
6" – 63-6DG  
9" – 63-9DG



Lavender

3" – 63-3DL  
6" – 63-6DL  
9" – 63-9DL



Light Blue

3" – 63-3DLB  
6" – 63-6DLB  
9" – 63-9DLB



Teal

3" – 63-3DT  
6" – 63-6DT  
9" – 63-9DT



Pink

3" – 63-3DP  
6" – 63-6DP  
9" – 63-9DP

**STEP 3:** Choose your security option.



**VEL**  
Electronic Keypad Lock  
**VELP**

Prox Card/Electronic Keypad Lock



**V21LB, V24LB, V27LB, V30LB**  
Breakaway Lock Bar



**VBLB-1**  
Single-Drawer Breakaway Lock Bracket\*



**VKL**  
Single-Drawer Key Lock

**STEP 4:** Choose your trays and dividers.

**Individual Trays & Dividers**



**3TR** – 3" Tray  
**3SD** – 3" Short Divider  
**3LD** – 3" Long Divider  
**3PAD** – 3" Clear Adjustable Divider\*\*



**6TR** – 6" Tray  
**6SD** – 6" Short Divider  
**6LD** – 6" Long Divider

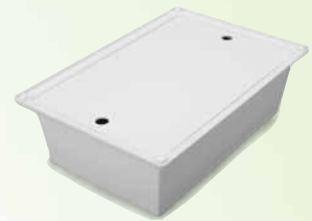

**6ST** – 6" Smooth Tray  
(No dividers available;  
Tray Lid optional)



**9TR** – 9" Tray  
**9SD** – 9" Short Divider  
**9LD** – 9" Long Divider



**TL** – Tray Lid  
(Fits all tray sizes)

**Tray Divider Sets**



**3TRD**  
3 Short, 3 Long



**6TRD**  
2 Short, 2 Long



**9TRD**  
1 Short, 1 Long



**3PT**  
3 Short, 1 Long, 8 Adjustable



**3TRD2**  
2 Short, 1 Long, 6 Adjustable



**3TRD3**  
2 Long, 11 Adjustable

\*Shown with plastic breakaway lock seal. Lock seals (VPBS) must be ordered separately.  
\*\*3" adjustable dividers (3PAD) can be used with 3SD and 3LD.



**STEP 5:** Choose your accessories.

## Top-Mounted Accessories



**VIV**  
IV Pole  
Fully extended length:  
86" (218.4cm)



**SK-1**  
Scope Pole – Fully extended length:  
86" (218.4cm). Holds 2 large-dia. scopes  
with working length of 80" (203.2cm).



**VMS**  
Monitor Shelf  
Maximum weight: 35 lbs. (15.9kg)



**VDS-1**  
Defibrillator Shelf  
Maximum weight: 35 lbs. (15.9kg)



**VUR1 & VTB6**  
Upper Accessory Rail  
with 6 Tilt Bins



**VUR1, VTB5 & VTB4**  
Upper Accessory Rail with  
5 Tilt Bins, 4 Tilt Bins



**FPMA**  
Flat-Panel Monitor Arm



**VUR1 & VUS-1**  
Upper Accessory Rail with Utility Shelf  
Maximum weight: 15 lbs. (6.8kg)



**VR3T-1**  
Upper Rack  
with Two 3" Half Trays



**VTD-2**  
Upper Rack Mount Tape Dispenser  
**VTD-1**  
Counter Top Tape Dispenser (not shown)



**VSS**  
Suture Shelf  
Includes 2 dividers per shelf



**VWC**  
Work Surface Cover

**STEP 5:** Choose your accessories. (cont'd)

**Side-Mounted Accessories**



**VFWS**  
Flip-Up Writing Surface  
Maximum weight: 35 lbs. (15.9kg)



**VPH**  
Push Handle



**VWAR-1**  
Wraparound Railing



**VSSB**  
Side Storage Bin



**VSCB-1**  
Scope Cabinet – Holds 3 small-dia. scopes  
with a working length of 36" (91.4cm)



**VCC**  
Catheter Container



**VWCH-1**  
Chart Holder



**VWB**  
Wire Basket

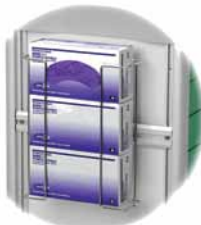

**VGB3**  
Triple Glove Box Holder



**VGB1-1**  
Single Glove Box Holder



**VSC5**  
5-Qt. Sharps Container



**VSG-1**  
Locking 5-Qt. Sharps Container  
& Glove Box



**VPW-1**  
Plastic Waste Basket



**VSW-1**  
Stainless Steel Waste Basket



**VOT-1**  
Oxygen Tank Holder  
Holds tanks up to 4" (10.2cm) in dia.

# Build-a-Cart

**STEP 5:** Choose your accessories. (cont'd)

## Back-Mounted Accessories



**VCW-1, PS**  
Cord Wrap & 120V Power Strip



**EPL**  
Exam Procedure Light\*



**VSP-1**  
Suction Pump Holder



**VRB-1**  
Resuscitation Board\*\*

\*Supplied with 12V 50W bulb. \*\*Resuscitation board also available as a side-mounted accessory.

## Accessory Value Packs

Preconfigured Value Packs are the most economical way to outfit your cart with productive tools and accessories.

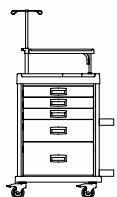

**Crash Value Pack (CVP)  
for 6324 Carts**  
IV Pole (VIV)  
Oxygen Tank Holder (VOT-1)  
Resuscitation Board (VRB-1)  
Defibrillator Shelf, Swivel Type (VDS-1)  
Breakaway Lock Bar (V24LB)

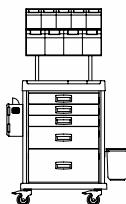

**Anesthesia Value Pack (AVP)**  
Upper Accessory Rail, 2 Rails (VUR2)  
Tilt Bins, 4 (VTB4)  
Tilt Bins, 5 (VTB5)  
Locking 5-Qt. Sharps Container (VSC5)  
Waste Basket, Plastic (VPW-1)

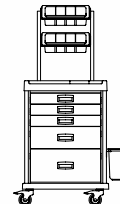

**Cast Cart Value Pack (CAST)**  
Waste Basket, Plastic (VPW-1)  
Upper Rack w/ Two 3" Half Trays (VR3T-1)  
Tray Divider Value Pack (TVP)

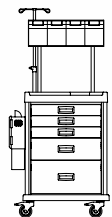

**IV Prep Value Pack (IVP)**  
IV Pole (VIV)  
Upper Accessory Rail, 1 Rail (VUR1)  
Tilt Bins, 4 (VTB4)  
Locking 5-Qt. Sharps Container  
& Glove Box (VSG-1)

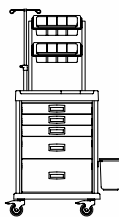

**Med/Surg Value Pack (MED)**  
IV Pole (VIV)  
Waste Basket, Plastic (VPW-1)  
Locking 5-Qt. Sharps  
Container & Glove Box (VSG-1)  
Upper Rack w/ Two 3" Half Trays (VR3T-1)

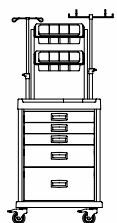

**Endo/PEG Value Pack (ENDO)**  
IV Pole (VIV)  
Upper Rack w/ Two 3"  
Half Trays (VR3T-1)  
Scope Pole Kit (SK-1)  
Tray Divider Value Pack (TVP)

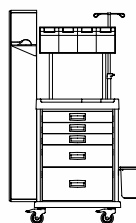

**Airway Value Pack (AIR)**  
IV Pole (VIV)  
Upper Accessory Rail, 1 Rail (VUR1)  
Tilt Bins, 4 (VTB4)  
Scope Cabinet (VSCB-1)  
Waste Basket, Plastic (VPW-1)

# Cell System

Designed to accommodate a variety of accessories including wire baskets, plastic trays, shelves, and locking drawers, the Stanley® InnerSpace® Cell System makes it easy to store everything from large bulky items to small medical devices.



- Cell panels designed to allow baskets and trays to operate like drawers
- Built-in stops prevent unnecessary removal
- Cells can be easily removed for reconfiguring, restocking, or cleaning



**VKB-1**  
Keyboard Shelf



**6321LB, 6324LB,  
6327LB, 6330LB**  
Lock Bar with Key Lock

## STEP 1: Choose cart size.

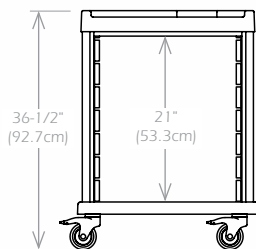

**6321WC**

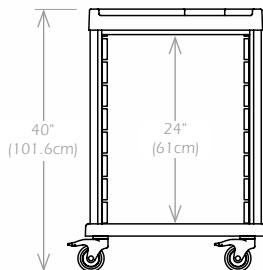

**6324WC**

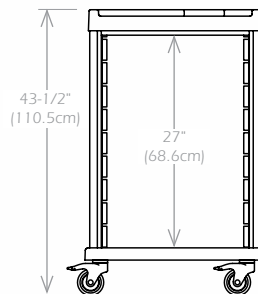

**6327WC**

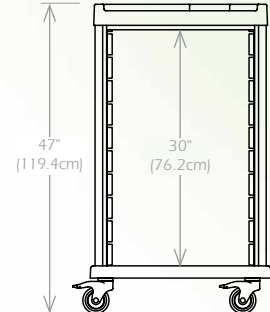

**6330WC**

## STEP 2: Choose interior accessories.

### Shelves, Tray & Locking Drawer



**18ES**

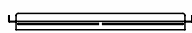

**18SH**  
Accept shelf dividers (PSDDV1)

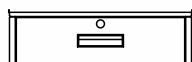

**18DR\***

### Wire Baskets



**3BA (3")**



**6BA (6")**



**9BA (9")**

### Trays



**3TR (3")**



**6TR (6")**

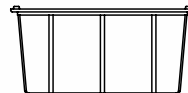

**9TR (9")**

### Trays



**3PT (3")**  
Pharmacy Tray (clear)  
with dividers



**18DRT (3")**  
Tray with dividers  
for 18DR

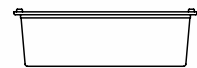

**6ST (6")**  
Smooth Tray

\*Requires 6 inches of linear Cell space. Interior drawer dimensions are: Height 4-1/2" (11.4cm), Width 18-1/4" (46.4cm), Depth 13-1/2" (34.3cm). Uses 3" tray model number 18DRT.

# Tray Trolleys

The Stanley® InnerSpace® tray trolley is a versatile lightweight cart utilizing the InnerSpace Cell System and accessory options.



- Versatile, compact, lightweight, easy to maneuver
- Applications: IV start, blood draw, med delivery, soiled scope transport
- Cell System accepts trays, baskets, locking drawers, and shelves
- Easy-close locking tambour door, slides left to right
- Optional flip-up writing surface (FWS)
- Can be configured numerous ways

Width: 18-5/8" (47.3cm)  
Depth: 28-1/2" (72.4cm)  
Height: 43-1/4" (109.9cm)

Easy Access to All Supplies



3750BDC Blood Draw Cart

Easy-Locking Door



3750DST Dirty Scope Transport



3750TT



3750TT With Optional Accessories



Tray trolley offers 27" of interior storage space for tray and basket accessories.

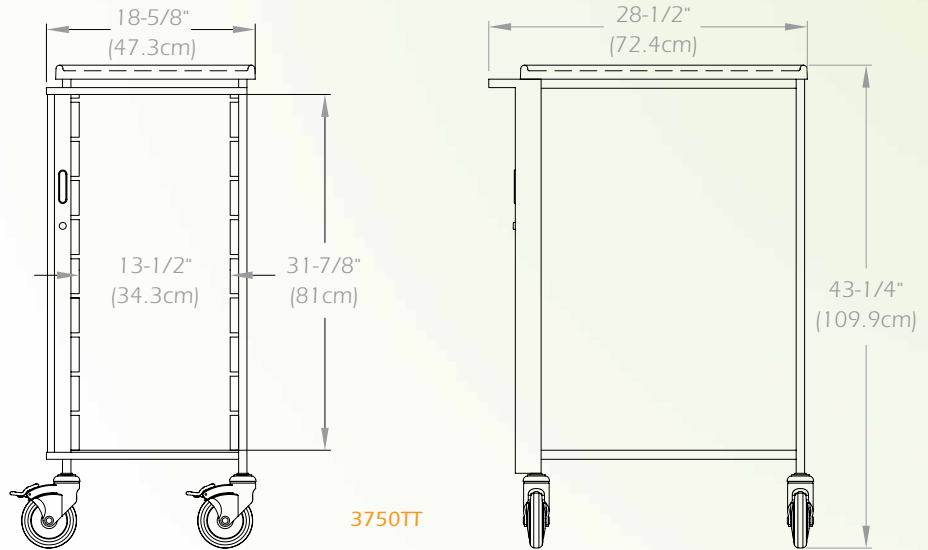

**STEP 1:** Choose interior accessories.

Shelves, Tray & Locking Drawer



**24ES**



**24SH**

Accept shelf dividers (PSDDV1)

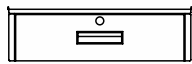

**24DR\***

Wire Baskets



**3BA (3")**

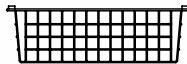

**6BA (6")**

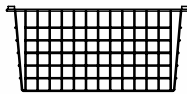

**9BA (9")**

Trays



**3TR (3")**



**6TR (6")**

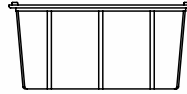

**9TR (9")**

Trays



**3PT (3")**

Pharmacy Tray (clear) with dividers

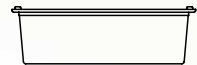

**6ST (6")**

Smooth Tray

**STEP 2:** Choose exterior accessories.



**CW, PS**

Cord Wrap & 120V Power Strip



**EPL**

Exam Procedure Light



**FWS**

Flip-Up Writing Surface



**SK-1**

Scope Pole



**WB-PL**

Plastic Waste Basket



**QWGBH**

Single Glove Box Holder



**IV**

IV Pole



**SC5**

5-Qt. Sharps Container

\*Requires 6 inches of linear Cell space. Interior drawer dimensions are: Height 4-1/2" (11.4cm), Width 12" (30.5cm), Depth 21" (53.3cm). Uses 3" tray model number 18DRT.

# Personal Workstations



- Ideal for small spaces
- Lightweight aluminum and steel cart is easy to move from room to room
- Applications: patient/blood pressure monitoring, mobile computing, bedside charting and procedures
- Effortless pneumatic-assisted height-adjustable work surface – 35-1/2" to 46" (91cm to 116.8cm)
- 5" full-swivel stem casters, 2 with locks
- 6450TD includes lower storage unit with locking drawers

Width: 23" (58.4cm)  
 Depth: 20-1/2" (52.1cm)  
 Height: 35-1/2" (90.2cm)  
 to 46" (116.8cm)



Height-Adjustable Work Surface



6450TD with VMHWB and V3HT



Flat-Panel Charting shown with FPMA



Laptop Charting



Tray & Dividers for 3" Drawers



Height-Adjustable Foot Lever

## Product Specs

Dimensions									
Carts	Exterior*			Work Surface Area				Linear Drawer Space	Weight
	Height	Width	Depth	Top		Pull-Out			
				Width	Depth	Width	Depth		
Description	Inches (cm)								Pounds (kg)
6321MINI	32 (81.3)	24 (60.9)	19.6 (49.9)	21 (53.3)	16 (40.6)	N/A		21 (53.3)	114 (51.7)
6321	36-1/2 (92.7)	27-1/8 (68.9)	21-1/8 (53.7)	23 (58.4)	16-1/2 (41.9)	15-1/2 (39.4)	13-3/4 (34.9)	21 (53.3)	133 (60.3)
6321W42C	33-1/2 (85.1)	27-1/8 (68.9)	21-1/8 (53.7)	23 (58.4)	16-1/2 (41.9)	15-1/2 (39.4)	13-3/4 (34.9)	21 (53.3)	130 (59.0)
6324	40 (101.6)	27-1/8 (68.9)	21-1/8 (53.7)	23 (58.4)	16-1/2 (41.9)	15-1/2 (39.4)	13-3/4 (34.9)	24 (61.0)	145 (65.8)
6327	43-1/2 (110.5)	27-1/8 (68.9)	21-1/8 (53.7)	23 (58.4)	16-1/2 (41.9)	15-1/2 (39.4)	13-3/4 (34.9)	27 (68.6)	162 (73.5)
6330	47 (119.4)	27-1/8 (68.9)	21-1/8 (53.7)	23 (58.4)	16-1/2 (41.9)	15-1/2 (39.4)	13-3/4 (34.9)	30 (76.2)	168 (76.2)
3750TT	42-1/4 (107.3)	18-1/2 (47.0)	28-3/4 (73.0)	23 (58.4)	16-1/2 (41.9)	20-1/4** (51.4)	14-1/2** (36.8)	N/A	75 (34.0)
6450TD	35-1/2 (90.2)	20-5/8 (52.4)	20-5/8 (52.4)	18-1/2 (47.0)	16-1/2 (41.9)	N/A		24 (61.0)	103 (46.7)

\*Overall dimensions, including casters.  
\*\*Dimensions shown are for flip-up writing surface (FWS).

Drawers			
Description	Interior		
	Height	Width	Depth
Description	Inches (cm)		
3" Drawer	2-11/16 (6.8)	21 (53.3)	14-5/8 (37.1)
6" Drawer	6-3/8 (16.2)	21 (53.3)	14-5/8 (37.1)
6" Narcotics Drawer (HND)	6-3/8 (16.2)	21 (53.3)	14-5/8 (37.1)
9" Drawer	9-3/4 (24.8)	21 (53.3)	14-5/8 (37.1)
Small 6450TD Drawer	2-1/2 (6.4)	13-1/8 (33.3)	10-3/8 (26.4)
Large 6450TD Drawer	6-1/8 (15.6)	13-1/8 (33.3)	10-3/8 (26.4)

Cell System Accessories			
Description	Interior		
	Height	Width	Depth
Description	Inches (cm)		
3" Tray (3PT, 3TR)	3 (7.6)	11-1/4 (28.6)	18-3/4 (47.6)
3" Tray, Divided (18DRT)	2-3/16 (5.6)	17-3/4 (45.1)	12-3/4 (32.4)
6" Tray (6ST, 6TR)	6 (15.2)	11-1/4 (28.6)	18-3/4 (47.6)
9" Tray (9TR)	9 (22.9)	11-1/4 (28.6)	18-3/4 (47.6)
3" Wire Basket (3BA)	3 (7.6)	12-3/4 (32.4)	19-1/2 (49.5)
6" Wire Basket (6BA)	6 (15.2)	12-3/4 (32.4)	19-1/2 (49.5)
9" Wire Basket (9BA)	9 (22.9)	12-3/4 (32.4)	19-1/2 (49.5)
Lockable Drawer (18DR)	4-1/2 (11.4)	18-1/4 (46.4)	13-1/2 (34.3)
Economy Shelf (18ES)	N/A	20-1/2 (52.1)	15-1/2 (39.4)
Metal Shelf (18SH)	N/A	20-1/2 (52.1)	15-1/2 (39.4)

## Product Specs

Small Carts 21, 24, 27 & 30	
Materials	
Shell	Steel Panel Construction with Aluminum Corner Posts
Base	Integrated Steel Bumpers Enclosed with Thermoformed ABS Shell
Drawers	Steel Drawer Fronts
Work Top	Seamless Thermoformed ABS with Raised Edge
Pull-Out Writing Surface	Blow-Molded ABS Plastic with Steel Reinforcement – 35 lbs. (15.9kg)
Drawer Glides	Steel Ball Bearing, 88-lb. (40kg) Weight Limit
Finish, Exterior Metal Surfaces	Durable, Thermoset Powder Coating Anodized Aluminum Posts.
Casters	5" Full-Swivel Plate Type with Steel Mounting Plates, 2 Locking and 1 Tracking Caster.
Locking System	Central Locking System with Key Lock is Standard. Optional Electronic Keyless Entry or Prox Card Access.
Accessory Mounting System	Side-Mounted Accessories: Vertically Adjustable Aluminum Rails. Top-Mounted Accessories: Reinforced Post Guides.

Tray Trolley	
Materials	
Frame	Lightweight Welded Tubular Construction
Sides and Back Panels	Foamed Resin
Work Top and Flip-Up Writing Surface*	Seamless Thermoformed ABS with Raised Edge
Casters	Medical Grade, 5" Full-Swivel Stem Type, 2 with Locks
Locking System	Tambour Door with Key Lock is Standard
Accessories	Optional Accessory Package 3750AP Available
*Flip-Up Writing Surface (FWS) Available as an Optional Accessory.	

Personal Workstation	
Materials	
Frame	Steel and Aluminum Construction
Work Top	Seamless Thermoformed ABS with Raised Edge
Casters	Medical Grade, 5" Full-Swivel Stem Type, 2 with Locks
Accessories	Wire Basket (VMHWB) and 3" Half-Tray (V3HT) Available. Mounting Bracket and Hardware Included.

## Model Numbers & Descriptions

Model No.	Description	Page	INSTALLATION	
			Factory	Field
<b>SMALL CARTS</b>				
<b>PRECONFIGURED CARTS, DRAWERS ONLY</b>				
6321MINI	Harmony 21, White, Mini Harmony	9		
6321W4	Harmony 21, White, Two 3" Drawers, One 6" Drawer, One 9" Drawer	7		
6321W42C	Harmony 21, White, Two 3" Drawers, One 6" Drawer, One 9" Drawer, 2" Casters			
6324W5	Harmony 24, White, Three 3" Drawers, One 6" Drawer, One 9" Drawer			
6324R5	Harmony 24, Red, Three 3" Drawers, One 6" Drawer, One 9" Drawer			
6324RVP	Harmony 24, Crash Cart with CVP, Red, Three 3" Drawers, One 6" Drawer, One 9" Drawer			
6324B5	Harmony 24, Blue, Three 3" Drawers, One 6" Drawer, One 9" Drawer			
6324BVP	Harmony 24, Anesthesia Cart with AVP, Blue, Three 3" Drawers, One 6" Drawer, One 9" Drawer			
6324Y4	Harmony 24, Isolation Cart, Yellow, Four 6" Drawers			
6324LINE	Harmony 24, Line Cart, PIC or Central, White Shell with Three 3", One 6", One 9" Lavender Drawers, includes, VUR2, VTB4, VTD-2, VIV, VSC5	8		
6324SUT	Harmony 24, Suture Cart, White Shell with Three 3", One 6", One 9" Green Drawers, includes VUR2, 2-VSS			
6327W6	Harmony 27, White, Four 3" Drawers, One 6" Drawer, One 9" Drawer	7		
6327PED	Harmony 27, Pediatric Emergency Cart, White Shell with Color-Coded Drawers	8		
6330W6	Harmony 30, White, Three 3" Drawers, Two 6" Drawers, One 9" Drawer	7		
6330R6	Harmony 30, Crash Cart, White Shell with Three 3", Two 6", One 9" Red Drawers	8		
6330B6	Harmony 30, Anesthesia Cart, White Shell with Three 3", Two 6", One 9" Blue Drawers			
6330Y6	Harmony 30, Isolation Cart, White Shell with One 3", Three 9" Yellow Drawers			

## Model Numbers & Descriptions

Model No.	Description	Page	INSTALLATION	
			Factory	Field
<b>SMALL CARTS</b>				
<b>PRECONFIGURED TRAYS/DIVIDERS, DRAWER DIVIDER SYSTEMS</b>				
3TRD	3" Tray with 3 Short & 3 Long Dividers	12	▪	▪
3PT	3" Pharmacy Tray, Clear		▪	▪
3TRD2	3" Tray with 2 Short, 1 Long & 6 Adj. Dividers		▪	▪
3TRD3	3" Tray with 2 Long & 11 Adj. Dividers		▪	▪
6TRD	6" Tray with 2 Short & 2 Long Dividers		▪	▪
9TRD	9" Tray with 1 Short & 1 Long Divider		▪	▪
<b>VALUE PACKS</b>				
AIR	Airway Value Pack	15	▪	
AVP	Anesthesia Value Pack		▪	
CAST	Cast Cart Value Pack		▪	
CVP	Crash Cart Value Pack		▪	
ENDO	Endo/PEG Value Pack		▪	
IVP	IV Prep Value Pack		▪	
MED	Med/Surg Value Pack	NS	▪	
TVP	Tray Divider Value Pack (3-3TR, 9-3SD/3LD, 1-6RT, 2-6LD)		▪	▪
<b>BUILD-A-CART Cart Shell, Accepts Drawers (must be ordered separately)</b>				
6321MINIWN	Harmony 21, White, Mini Harmony, Without Drawers	9		
6321WN	Harmony 21, White, Without Drawers	11		
6321RN	Harmony 21, Red, Without Drawers			
6321BN	Harmony 21, Blue, Without Drawers			
6321YN	Harmony 21, Yellow, Without Drawers			
6324WN	Harmony 24, White, Without Drawers			
6324RN	Harmony 24, Red, Without Drawers			
6324BN	Harmony 24, Blue, Without Drawers			
6324YN	Harmony 24, Yellow, Without Drawers			
6327WN	Harmony 27, White, Without Drawers			
6327RN	Harmony 27, Red, Without Drawers			
6327BN	Harmony 27, Blue, Without Drawers			
6327YN	Harmony 27, Yellow, Without Drawers			
6330WN	Harmony 30, White, Without Drawers			
6330RN	Harmony 30, Red, Without Drawers			
6330BN	Harmony 30, Blue, Without Drawers			
6330YN	Harmony 30, Yellow, Without Drawers			
<b>Individual Drawers</b>				
63-3DW	3" Harmony Drawer, White	11	▪	
63-3DR	3" Harmony Drawer, Red		▪	
63-3DB	3" Harmony Drawer, Blue		▪	
63-3DY	3" Harmony Drawer, Yellow		▪	
63-3DO	3" Harmony Drawer, Orange		▪	
63-3DG	3" Harmony Drawer, Green		▪	
63-3DL	3" Harmony Drawer, Lavender		▪	
63-3DLB	3" Harmony Drawer, Light Blue		▪	
63-3DT	3" Harmony Drawer, Teal		▪	
63-3DP	3" Harmony Drawer, Pink		▪	
63-6DW	6" Harmony Drawer, White		▪	
63-6DR	6" Harmony Drawer, Red		▪	
63-6DB	6" Harmony Drawer, Blue		▪	
63-6DY	6" Harmony Drawer, Yellow		▪	
63-6DO	6" Harmony Drawer, Orange		▪	
63-6DG	6" Harmony Drawer, Green		▪	
63-6DL	6" Harmony Drawer, Lavender		▪	
63-6DLB	6" Harmony Drawer, Light Blue		▪	
63-6DT	6" Harmony Drawer, Teal		▪	
63-6DP	6" Harmony Drawer, Pink		▪	
63-9DW	9" Harmony Drawer, White		▪	
63-9DR	9" Harmony Drawer, Red		▪	
63-8DB	9" Harmony Drawer, Blue		▪	
63-9DY	9" Harmony Drawer, Yellow		▪	
63-9DO	9" Harmony Drawer, Orange		▪	
63-9DG	9" Harmony Drawer, Green		▪	
63-9DL	9" Harmony Drawer, Lavender		▪	
63-9DLB	9" Harmony Drawer, Light Blue		▪	
63-9DT	9" Harmony Drawer, Teal	▪		
63-9DP	9" Harmony Drawer, Pink	▪		
HDC	Harmony Drawer Cover, White, Fits All Harmony Drawers	10	▪	



## Model Numbers & Descriptions

Model No.	Description	Page	INSTALLATION	
			Factory	Field
<b>BUILD-A-CART (cont'd) Cart with Cell Panels Installed, Accepts Trays, Baskets &amp; 6" Locking Drawer (must be ordered separately)</b>				
6321WC	Harmony 21, White, Cell Panels Installed	16		
6324WC	Harmony 24, White, Cell Panels Installed			
6327WC	Harmony 27, White, Cell Panels Installed			
6330WC	Harmony 30, White, Cell Panels Installed			
<b>Cell System Accessories</b>				
3TR	3" Tray	16	▪	▪
3HT	3" Half Tray	NS		
6ST	6" Smooth Tray, No Seams, No Dividers	16	▪	▪
6TR	6" Tray		▪	▪
9TR	9" Tray		▪	▪
3SD	3" Short Tray Divider		▪	▪
3LD	3" Long Tray Divider	12	▪	▪
6SD	6" Short Tray Divider		▪	▪
6LD	6" Long Tray Divider		▪	▪
9SD	9" Short Tray Divider		▪	▪
9LD	9" Long Tray Divider	NS	▪	▪
3PSD	3" Clear Short Divider		▪	▪
3PLD	3" Clear Long Divider		▪	▪
3PAD	3" Clear Adjustable Divider		12	▪
3BA	3" Wire Basket	16	▪	▪
6BA	6" Wire Basket		▪	▪
9BA	9" Wire Basket		▪	▪
PSDDV1	Shelf Dividers for 18SH Metal Shelf	NS	▪	▪
18DR	Lockable Drawer	16	▪	▪
18DRT	3" Divided Tray (6 Compartments) for 18DR Locking Drawer		▪	▪
18ES	Economy Shelf		▪	▪
18SH	Metal Shelf		▪	▪
VKB-1	Keyboard Shelf (Uses 9" of Interior Space)		▪	▪
<b>Lock Bar for Cell System</b>				
6321LB	Lock Bar for Harmony 21 Cell System	16	▪	
6324LB	Lock Bar for Harmony 24 Cell System		▪	
6327LB	Lock Bar for Harmony 27 Cell System		▪	
6330LB	Lock Bar for Harmony 30 Cell System		▪	
<b>SMALL CART EXTERIOR ACCESSORIES</b>				
<b>Top-Mounted Accessories</b>				
SK-1	Scope Pole Kit	13	▪	
VDS-1	Defibrillator Shelf, Swivel-Type – Width 18-3/4" (47.6cm), Depth 12-3/4" (32.4cm)		▪	
VIV	IV Pole		▪	
VMS	Monitor Shelf – Width 18-3/4" (47.6cm), Depth 17-3/4" (45.1cm)		▪	
VR3T-1	Upper Rack w/Two 3" Half Trays		▪	
VTB4	Tilt Bins, 4 (Upper Posts & Rail Sold Separately) – Width 5-1/2" (14cm), Depth 5" (12.7cm), Height 7-1/2" (19cm)		▪	
VTB5	Tilt Bins, 5 (Upper Posts & Rail Sold Separately) – Width 4-1/2" (11.4cm), Depth 4" (10.2cm), Height 6" (15.2cm)		▪	
VTB6	Tilt Bins, 6 (Upper Posts & Rail Sold Separately) – Width 3-1/4" (8.3cm), Depth 3-3/4" (9.5cm), Height 4" (10.2cm)		▪	
VUR1	Upper Accessory Rail, 1 Rail, Includes Posts	NS	▪	
VUR2	Upper Accessory Rail, 2 Rails, Includes Posts		▪	
VUS-1	Upper Utility Shelf (Requires UR1 or UR2 Rails, Sold Separately) – Width 19-3/4" (50.2cm), Depth 9-3/4" (24.8cm)	13	▪	
VTD-1	Tape Dispenser, Counter Top		▪	▪
VTD-2	Tape Dispenser, Upper Rack Mount		▪	▪
VWC	Work Surface Cover, Clear		▪	▪
VSS	Suture Shelf, Includes 2 Magnetic Shelf Dividers		▪	▪

Model No.	Description	Page	INSTALLATION	
			Factory	Field
<b>SMALL CART EXTERIOR ACCESSORIES (cont'd)</b>				
Side-Mounted Accessories**				
VCC	Catheter Container – Height 28" (71.1cm), Depth 3-1/4" (8.3cm)	14	▪	▪
VFWS	Flip-Up Writing Surface for Harmony Carts		▪	▪
VGB1-1	Glove Box Holder, Wire, Single		▪	▪
VGB3	Glove Box Holder, Wire, Triple		▪	▪
VMR-1	Accessory Mounting Rail (Required for Side-Mounted Accessories)	NS	▪	▪
VOT-1	Oxygen Tank Holder	14	▪	▪
VPH	Push Handle, Aluminum		▪	▪
VPW-1	Waste Basket, Plastic		▪	▪
VSC5	Locking 5-Qt. Sharps Container – Height 10-3/4" (27.3cm), Depth 5-1/2" (14cm), Width 11-3/4" (29.8cm)		▪	▪
VSCB-1*	Scope Cabinet – Height 60" (152.4cm), Depth 8-5/8" (21.9cm), Width 13-3/4" (34.9cm)		▪	▪
VSG-1	Locking 5-Qt. Sharps Container & Glove Box		▪	▪
VSSB	Side Storage Bins, Metal		▪	▪
VSW-1	Waste Basket, Stainless Steel		▪	▪
VWAR-1	Wraparound Railing		▪	▪
VWB	Wire Basket		▪	▪
VWCH-1	Chart Holder – Height 10" (25.4cm), Depth 2-1/4" (5.7cm), Width 12-1/2" (31.8cm)		▪	▪
Mounting rails and mounting hardware included with side-mounted accessories.				
Back-Mounted Accessories				
EPL	Exam Procedure Light	15	▪	
PS	Power Strip w/15-Ft. Cord (Mounts on Back of Cart)		▪	
VCW-1	Cord Wrap (Mounts on Back of Cart)		▪	
VRB-1**	Polyethylene Resuscitation Board		▪	▪
VSP-1	Suction Pump Holder – Height 10-1/8" (25.7cm), Depth 7-7/8" (20cm), Width 19" (48.3cm)		▪	
Other Accessories				
FPMA	Flat-Panel Monitor Arm (22 Lbs. Max. Load)	10	▪	
VCS2	2" Locking Casters, Set of 4, For Use with Harmony 21 Only	NS	▪	
VTC	Tracking Caster		▪	
VKB-1	Articulating Keyboard/Laptop Holder		▪	
HDC	Drawer Cover	10	▪	
VPT	Pass-Through Hole		▪	
<b>HARMONY LOCKING OPTIONS</b>				
VBLB-1	Breakaway Lock for 1 Drawer – Specify Drawer	12	▪	
VEL	Electronic Lock, Keyless Entry		▪	
VELP	Electronic Lock for Prox Cards			
ILS-CARD	Prox Cards	NS		
VPBS	Plastic Breakaway Seals, Package of 100		▪	▪
VKL	Individual Drawer Lock, Key Type, For Use With Top Drawer Only	12	▪	
V21LB	Harmony 21 Breakaway Lock Bar		▪	
V24LB	Harmony 24 Breakaway Lock Bar		▪	
V27LB	Harmony 27 Breakaway Lock Bar		▪	
V30LB	Harmony 30 Breakaway Lock Bar		▪	
Replacement Battery Packs				
KE-BT	Battery Pack for Electronic Lock, 8 AA Battery Pack (Used with Harmony V)	NS		▪
KE-BTC	Battery Pack for Electronic Lock, 8 C Battery Pack (Used with Harmony 21, 24, 27 & 30)			
<b>TRAY TROLLEY</b>				
3750TT	Cart, Tray Trolley Supply Cart, 9 Cell, Locking Lateral Tambour Door	17		
3750AP	Accessory Pack (2-3TR, 4-3SD/3LD, 2-6TR, 4-6SD/6LD, 1-9BA)	NS	▪	▪
3750KE	Keyless Entry for 3750TT Tray Trolley		▪	
FWS	Flip-Up Writing Surface for Tray Trolley	18	▪	
24DR	6" Lockable Drawer		▪	▪
24SH	Metal Shelf, Accepts Dividers		▪	▪
24DI	Metal Divider for 24"D Shelf	NS	▪	▪
24ES	Economy Shelf	18	▪	▪
<b>PERSONAL WORKSTATION</b>				
6450TD	MyHarmony Cart with Drawer Box	19		
V3HT	MyHarmony 3" Half Tray with Bracket		▪	▪
VMHWB	MyHarmony Wire Basket with Bracket		▪	▪

\*Scope cabinet CANNOT be used in conjunction with a Harmony 21. \*\*Field installation applies to side-mount version. Accessory rail (VMR-1) required for side mounting.

# Specialty Small Carts

## Double-Wide Half Carts



A small cart with double the storage space! The double-wide half cart can hold either 54 inches of storage accessories with no roll top or 42 inches of storage accessories with lockable roll-top closure. Uses the same 24-inch-deep accessories as the InnerSpace tray trolley.



4300ERCP

Includes Two Flip-Up Writing Surfaces  
(Accessories Sold Separately)  
27"D x 38"W x 42"H



4300HC

Includes Locking Roll-Top Door  
(Accessories Sold Separately)  
27"D x 38"W x 42"H

## Suture Carts



4700SC



Lockable Double-Sided Suture Storage  
19-1/4"D x 27-3/4"W x 52-1/2"H



4750SC

Open Suture Storage System  
22-1/2"D x 20-1/2"W x 62-1/2"H

# Stanley InnerSpace keeps you organized and adapts to your changing needs.

Call **800.467.7224** today to schedule a free onsite storage analysis.



Complete Turnkey Storage & Inventory Management Solutions



Open Procedure Carts



5000 Series Stainless Steel Cabinet for Operating Rooms & Other Clinical Areas



Lockable Procedure Carts



5000 Series Laminated Cabinets for Cath Labs & Interventional Radiology



Lockable Roll-Top Cabinets



**STANLEY**

# InnerSpace®

P.O. Box 2186 • Grand Rapids, MI 49501-2186  
616.224.2828 • Toll-Free: 800.467.7224  
Fax: 866.644.1745

PRSRT STD  
US POSTAGE  
PAID  
GRAND RAPIDS MI  
PERMIT NO 1241

[StanleyInnerSpace.com](http://StanleyInnerSpace.com)

© 2010 Stanley InnerSpace. All Rights Reserved. Catalog No. HRC0004 Litho in USA

Call **800.467.7224** today to schedule  
a free onsite storage analysis, including ways  
InnerSpace can help with Lean initiatives!



 **Mixed Sources**  
Product group from well-managed  
forests and other controlled sources  
[www.fsc.org](http://www.fsc.org) Cert no. SW-COC-003618  
© 1996 Forest Stewardship Council

[StanleyInnerSpace.com](http://StanleyInnerSpace.com)